

CRL

Central Research Laboratories

a DESTACO company



Glove Ports & DURABLE™ Glove Sleeve Systems

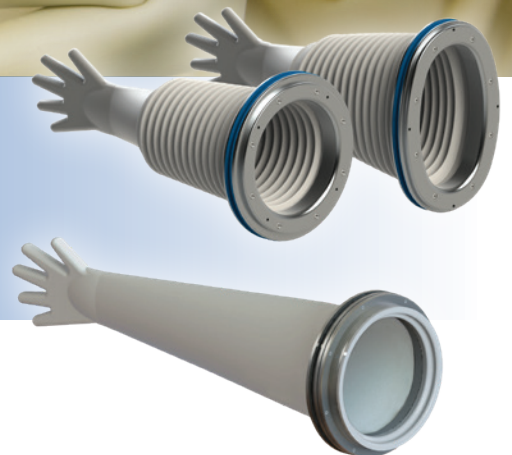

Visual Selection Guide | Life Science



A Legacy of Innovative Experience

In 1945, at the dawn of the Atomic Age, three scientists from the Massachusetts Institute of Technology founded Central Research Laboratories (CRL) and pioneered early development of safer methods for handling hazardous and toxic products produced by this industry. With a legacy of over 70 years of innovative experience, CRL has continued to develop and build a full line of remote handling and containment solutions including Telemanipulators, Transfer Systems, Glove Ports, and Waste Drum Transfer Systems. These products allow operators to safely and efficiently perform various tasks in Nuclear and Life Science industries across the world.

The CRL team has the experience, expertise, and technologies to help with all your remote handling needs and strives to continually improve and develop innovative technology that help its customers achieve the highest level of performance. CRL is committed to its customers' needs and developing the best solutions for every project. Every product manufactured is created with those specific needs in mind to deliver the most customized solution available for every application.

crlsolutions.com

Central Research
laboratories

RED WING, MINN.

Proven Technology. Customized Solutions.

A safe, fast-change glove port solution with multiple accessories to expand operational capabilities of the isolator or RABS

The CRL Push-Through Glove Port System allows for the interchangeability between gloves and accessories without losing containment or risking the spread of contamination. The two main components of the system are the glove ring, which mounts to the wall or window and the support ring or accessory that creates a leak-tight compression seal inside the glove ring.

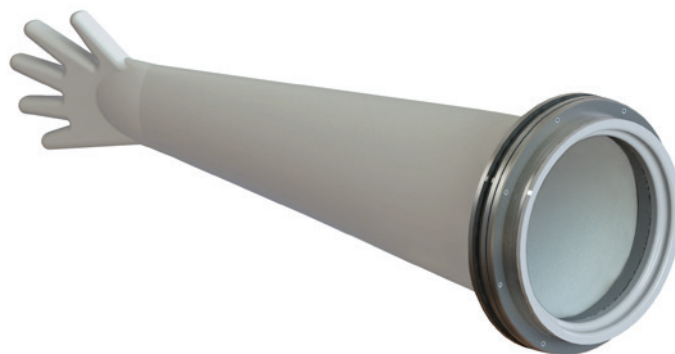

Round Push-Through Glove Port shown with long glove

- Push-through accessories: viewing windows, bag-out bags, plugs, and utility panels
- Safety covers available; sensors added as customizable option
- Clamp-in or weld-in glove rings available
- Push-through ejection tools available for safe, fast glove or accessory change

Size

- 4 in (102 mm)
- 6 in (152 mm)
- 8 in (203 mm)
- 10 in (254 mm)
- 12 in (305 mm)
- 15 in (381 mm)

Shape

- R** ROUND
- V** OVAL (only available in size 8 & 12)

Glove Ring, Backing Ring and Sealing Nut Material

- S** STAINLESS STEEL
- A** ALUMINUM

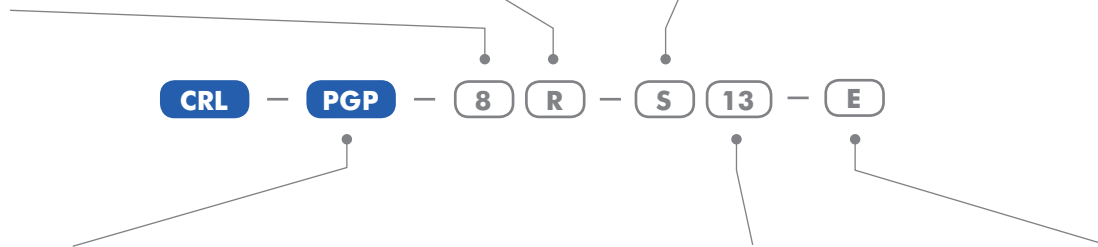

Model

PGP Push-Through Glove Port

Wall Thickness

- C** CLAMP-IN (up to 25 mm*)
- 9** mm (for weld-in use)
- 13** mm (for weld-in use)
- 16** mm (for weld-in use)

Gasket Material

- N** NEOPRENE
- E** EPDM
- B** BUNA-N
- S** SILICONE

*Maximum Clamp-in Wall Thickness

| | |
|------------------|-----------------|
| 4 in | 14 mm (0.56 in) |
| 6 in | 22 mm (0.88 in) |
| 8, 10, 12, 15 in | 25 mm (1 in) |

8 in. (203.2 mm) Round Push-Through Glove Port Assembly | Clamp-in

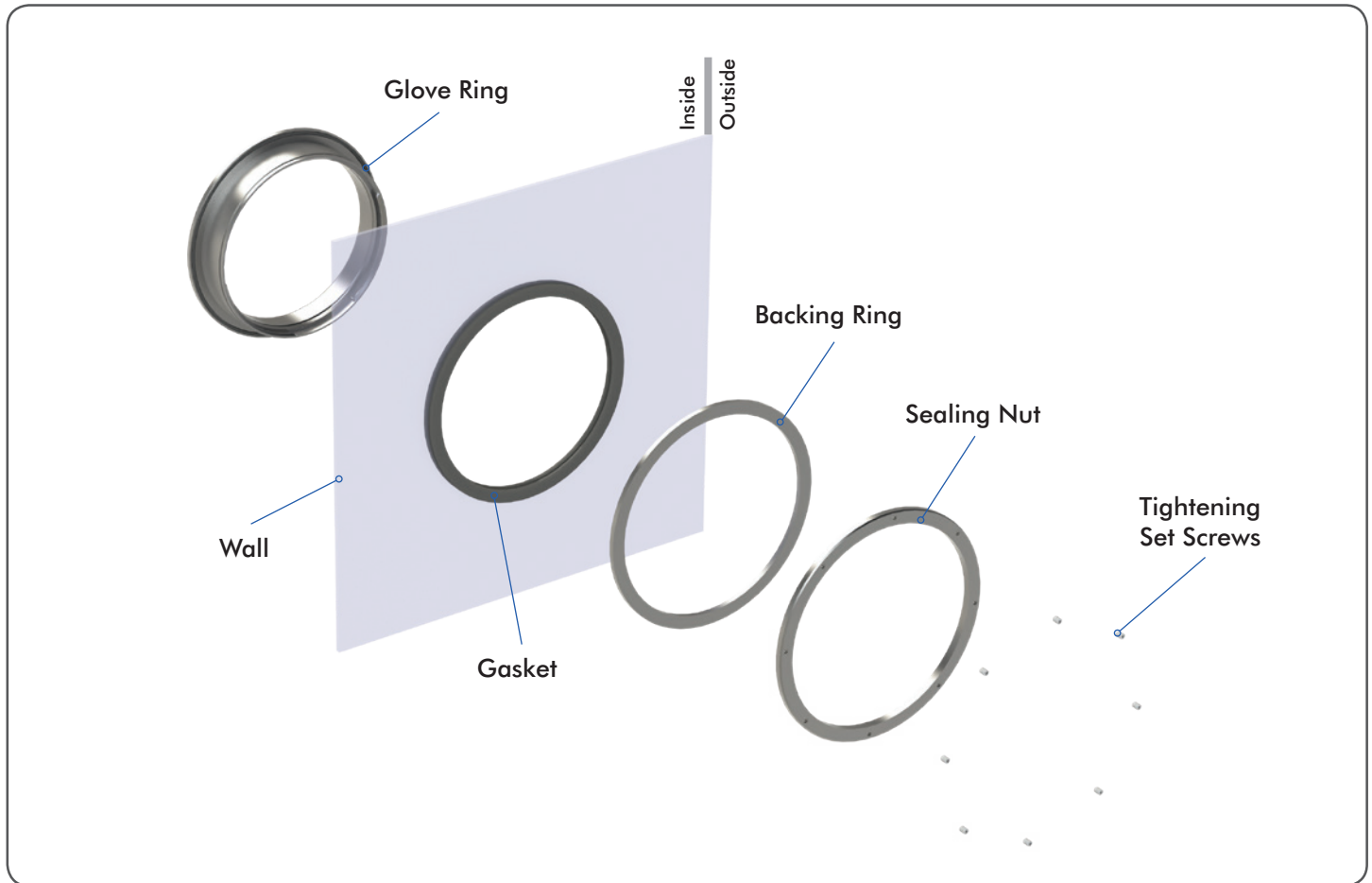

Round Push-Through Glove Port in Aluminum

8 in. (203.2 mm) Round Push-Through Glove Ring Assembly **CRL-PGP-8R-AC-E** (Standard Configuration)

- Clamp-in
- Aluminum 6061
- Includes EPDM Gasket and Comfort Ring

8 in. (203.2 mm) Round Push-Through Glove Ring Assembly **CRL-PGP-8R-SC-E** (Standard Configuration)

- Clamp-in
- 304L SST
- Includes EPDM Gasket and Comfort Ring

Accessories | Standard materials listed below. Inquire for additional, non-standard material configurations.



Glove Support Ring

- HDPE
- EPDM O-ring for ≤ 30 mil gloves

| | |
|------------------|-------------|
| CRL-43005 | 4 in Round |
| CRL-42962 | 6 in Round |
| CRL-42731 | 8 in Round |
| CRL-49484 | 10 in Round |
| CRL-42977 | 12 in Round |
| CRL-42980 | 15 in Round |
| CRL-39584 | 8 in Oval |
| CRL-42995 | 12 in Oval |



Ejectable Plug

- HDPE
- EPDM O-rings

| | |
|------------------|-------------|
| CRL-42965 | 4 in Round |
| CRL-42968 | 6 in Round |
| CRL-42732 | 8 in Round |
| CRL-49480 | 10 in Round |
| CRL-42971 | 12 in Round |
| CRL-49481 | 15 in Round |
| CRL-39585 | 8 in Oval |
| CRL-42998 | 12 in Oval |



Glove Support Ring

- HDPE
- EPDM O-ring for ≥ 30 mil gloves

| | |
|------------------|-------------|
| CRL-49485 | 4 in Round |
| CRL-49486 | 6 in Round |
| CRL-42742 | 8 in Round |
| CRL-49487 | 10 in Round |
| CRL-49488 | 12 in Round |
| CRL-49489 | 15 in Round |
| CRL-49490 | 8 in Oval |
| CRL-49491 | 12 in Oval |



Ejectable Window

- HDPE
- 0.25 in. (6 mm) thick Safety Glass
- EPDM O-rings

| | |
|------------------|-------------|
| CRL-42943 | 4 in Round |
| CRL-49475 | 6 in Round |
| CRL-42767 | 8 in Round |
| CRL-49476 | 10 in Round |
| CRL-42950 | 12 in Round |
| CRL-49477 | 15 in Round |
| CRL-49478 | 8 in Oval |
| CRL-49479 | 12 in Oval |



Bag

- PVC with O-ring sealed into cuff
- 0.008 in. (0.2 mm) thick
- specify length (mm) - xxx

| | |
|------------------|-------------|
| CRL-47966 | 4 in Round |
| CRL-38133 | 6 in Round |
| CRL-21351 | 8 in Round |
| CRL-49482 | 10 in Round |
| CRL-32160 | 12 in Round |
| CRL-34396 | 15 in Round |
| CRL-38283 | 8 in Oval |
| CRL-41936 | 12 in Oval |



Safety Cover

- SST
- 0.62 in (16 mm) thick
- EPDM O-rings

| | |
|------------------|-------------|
| CRL-49467 | 4 in Round |
| CRL-49468 | 6 in Round |
| CRL-49469 | 8 in Round |
| CRL-49470 | 10 in Round |
| CRL-49471 | 12 in Round |
| CRL-49472 | 15 in Round |
| CRL-49473 | 8 in Oval |
| CRL-49474 | 12 in Oval |

Spanner Wrench **CRL-33579** **ALSO AVAILABLE**



Bag Support Ring

- HDPE
- EPDM O-rings

| | |
|------------------|-------------|
| CRL-43005 | 4 in Round |
| CRL-42974 | 6 in Round |
| CRL-42740 | 8 in Round |
| CRL-49483 | 10 in Round |
| CRL-42977 | 12 in Round |
| CRL-42980 | 15 in Round |
| CRL-39584 | 8 in Oval |
| CRL-42995 | 12 in Oval |



Ejection Tool

- Short Ejection Tool

| | |
|------------------|-------------|
| CRL-32126 | 4 in Round |
| CRL-39830 | 6 in Round |
| CRL-46412 | 8 in Round |
| CRL-37912 | 10 in Round |
| CRL-31682 | 12 in Round |
| CRL-34402 | 15 in Round |
| CRL-45908 | 8 in Oval |
| CRL-30914 | 12 in Oval |

Clean, high quality compression fit glove port

- Available in round and oval configurations
- 316L Stainless Steel and Aluminum versions available
- For use with long gloves or DURABLE™ Glove Sleeve Systems

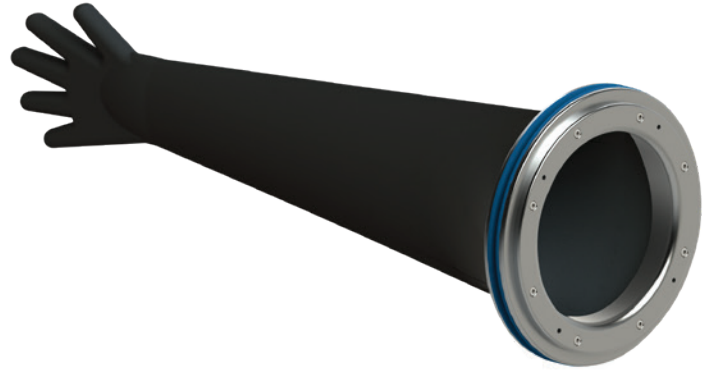

Round Fixed Glove Port shown with long glove

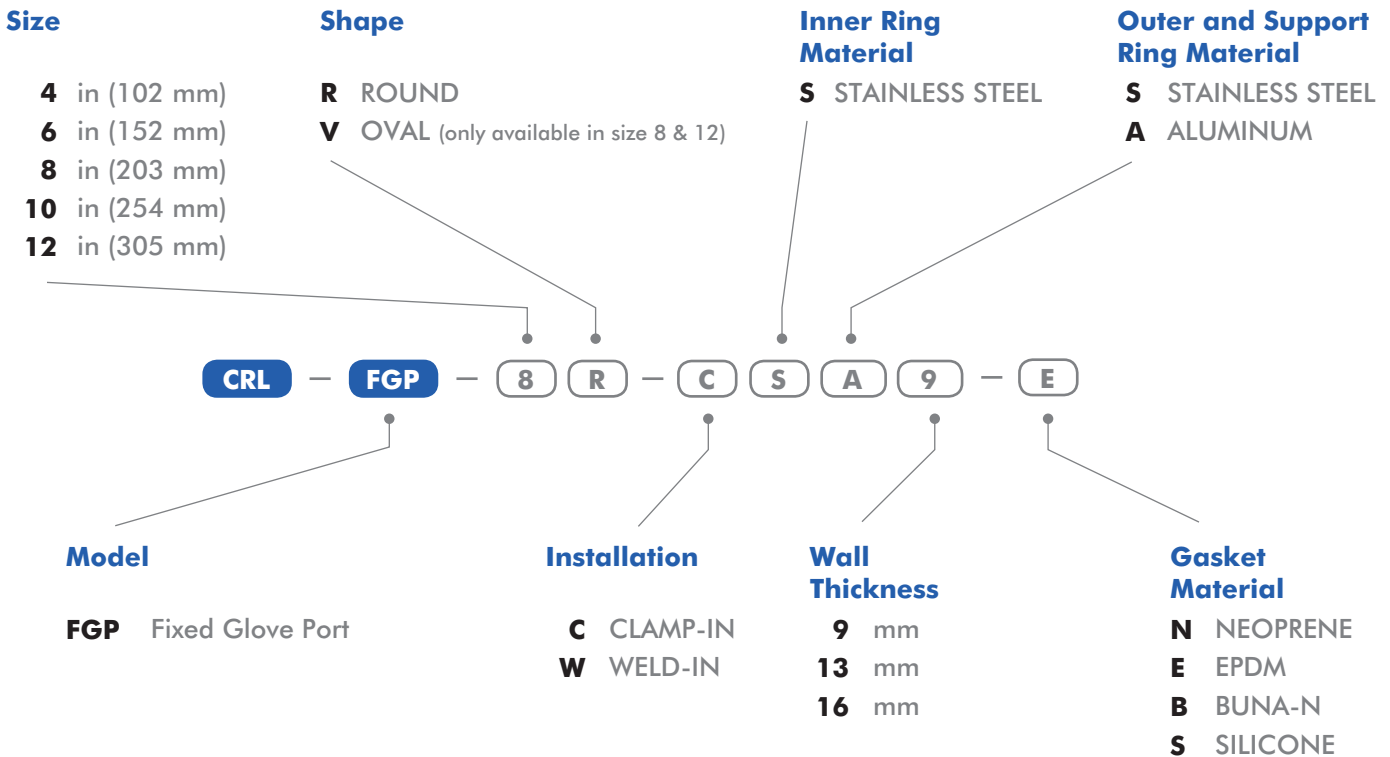

Fixed Glove Port Assembly | Clamp-in

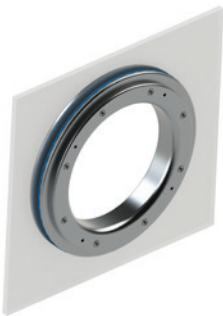
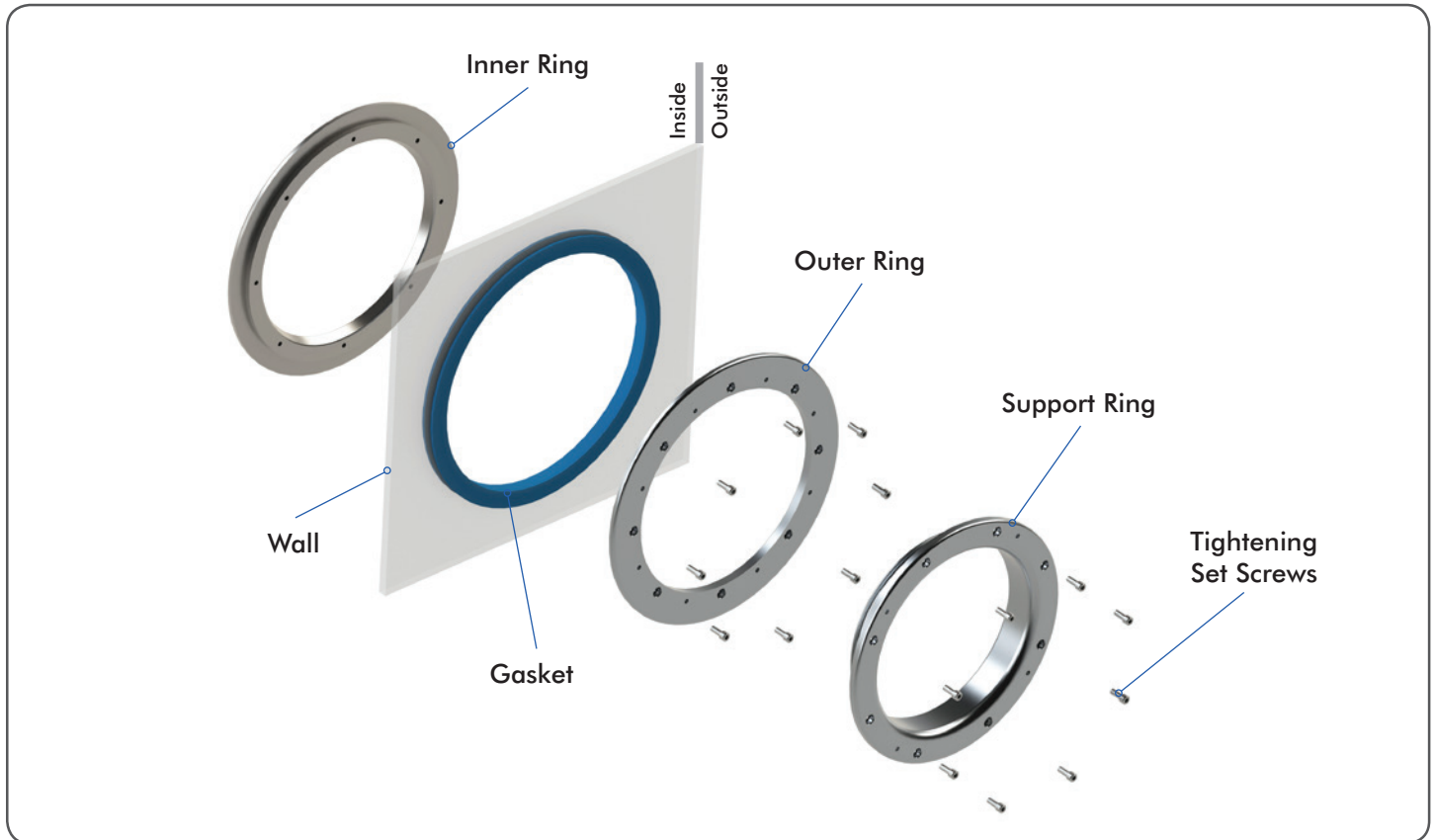

8 in. Round Compression Mount Glove Ring Assembly **CRL-FGP-8R-CSA9-E** (Standard Configuration)

- 316L SST inner ring
- 9 mm wall thickness
- EPDM gasket



Oval Compression Mount Glove Ring Assembly **CRL-FGP-8V-CSA9-E** (Standard Configuration)

- 7 in x 11 in [178mm x 279mm]
- 316L SST inner ring
- 9 mm wall thickness
- EPDM gasket

Designed to minimize down time and maximize cost savings for life sciences applications

- Available in round and oval configurations
- For use with Fixed Glove Ports
- Available with push-through wrist cuff ring for safe, fast short glove change or compression fit wrist cuff ring
- Made of polyurethane and CSM for high durability and puncture and chemical resistance
- Can also be customized to fit any current port configurations

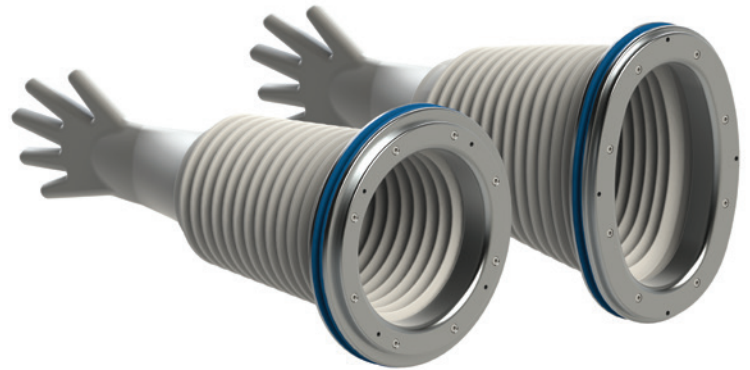

Round and Oval DURABLE™ Accordion Sleeves shown with Fixed Glove Ports

Size

- 6** in (152 mm)
- 8** in (203 mm)
- 10** in (254 mm)
- 12** in (305 mm)

Shape

- R** Round
- V** OVAL (only available in size 8 & 12)

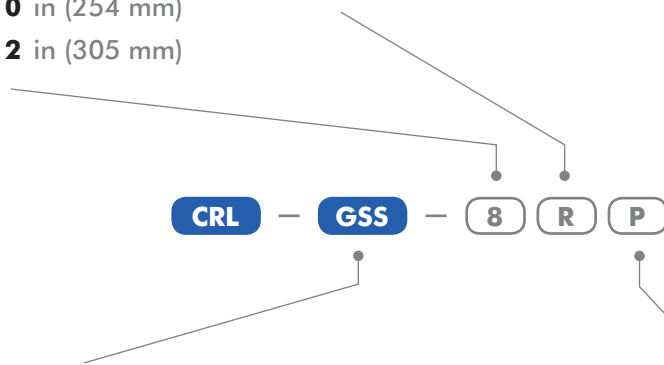

Model

GSS DURABLE™ Glove Sleeve Systems

Glove Installation

- F** Fixed (4.4 in. glove wrist cuff ring)
- P** Push-Through (4 in. glove wrist cuff ring)

Fixed Glove Port | Durable™ Accordion Sleeve

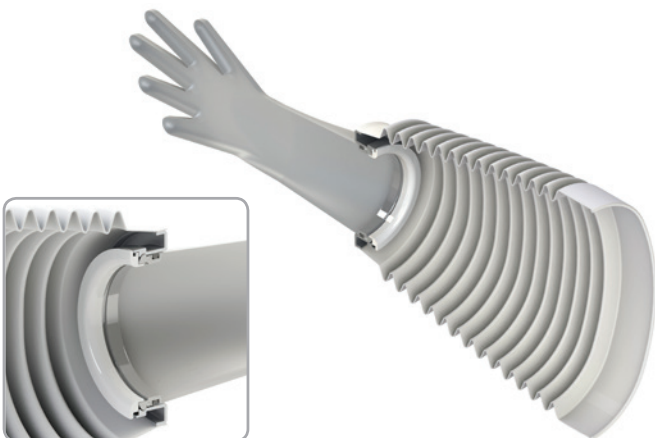

Oval DURABLE™ Accordion Sleeve with Push-Through Wrist Cuff

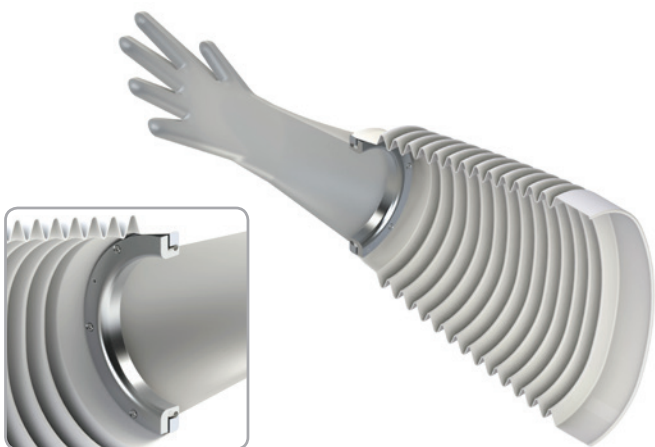

Oval DURABLE™ Accordion Sleeve with Compression Mount Wrist Cuff

Push-Through Wrist Cuff Ring

8 in. (203 mm) Round DURABLE™ Accordion Sleeve with Push-Through Wrist Cuff Ring

CRL-GSS-8RP (Standard Configuration)

- Includes Comfort Ring
- Glove and port not included

8 in. (203 mm) Oval DURABLE™ Accordion Sleeve with Push-Through Wrist Cuff Ring

CRL-GSS-8VP (Standard Configuration)

- Includes Comfort Ring
- Glove and port not included

Compression Mount Wrist Cuff Ring

8 in. (203 mm) Round DURABLE™ Accordion Sleeve with Compression Mount Wrist Cuff Ring

CRL-GSS-8RF (Standard Configuration)

- Glove and port not included

8 in. (203 mm) Oval DURABLE™ Accordion Sleeve with Compression Mount Wrist Cuff Ring

CRL-GSS-8VF (Standard Configuration)

- Glove and port not included

Accessories



4 in. Round Support Ring

CRL-43006

- Used with 4 in. Push-Through Cuff Short Glove
- HDPE
- Includes EPDM O-ring



4 in. Round Ejection Tool

CRL-32126

- Used with 4 in. Push-Through Cuff Ring

The Benefit of Using CRL DURABLE™ Accordion Sleeves With Short Gloves INSTEAD OF LONG GLOVES

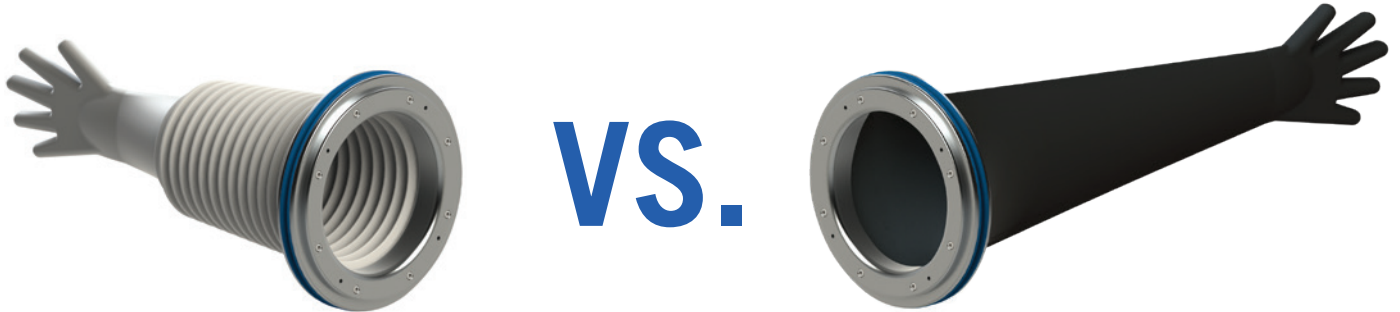

CRL DURABLE™ ACCORDION SLEEVE with Push-Through Short Glove

STANDARD LONG GLOVE in Fixed Glove Port

| Cost | Change Time |
|--------------------|---------------|
| <p>Short Glove</p> | <p>1 MIN.</p> |

| Cost | Change Time |
|-------------------|-----------------|
| <p>Long Glove</p> | <p>15 MIN.*</p> |

Cost/Change Process Comparison

+

 x

 =

1 DURABLE™ Accordion Sleeve (lifespan of up to 2 years)

10 short gloves

x

 =

10 long gloves

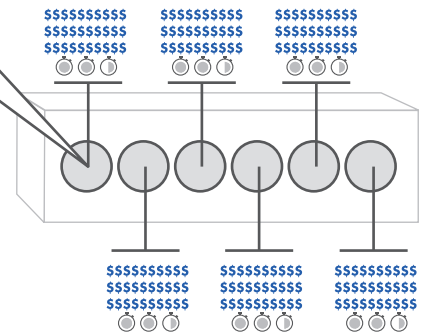
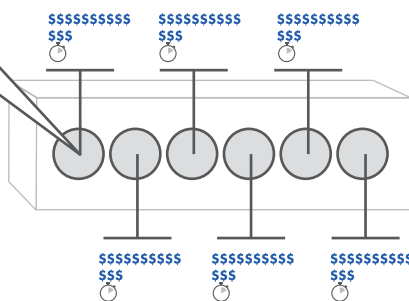

SAVE TIME. SAVE MONEY.

* Source: Energy System News, "New Design for Glove Changeout Safer, Saves Money", March 1994



CRL Headquarters/Support

3965 Pepin Avenue
Red Wing, MN 55066
Tel: +1-651-385-2142
Toll Free: +1-800-934-1562
info@crlsolutions.com

crlsolutions.com